

# Michael Baker

**I N T E R N A T I O N A L**

March 19, 2024

Alex Smith  
Philadelphia Art Commission  
City of Philadelphia  
1515 Arch Street  
Philadelphia PA 19102

RE: SEPTA North Broad ADA Improvements

Dear Alex,

Michael Baker International (MBI) has been contracted by SEPTA to lead the design of this project. On behalf of SEPTA, MBI respectfully requests the review of SEPTA's North Broad ADA Improvements Project. This project includes the following three stations:

- Hunting Park  
4200 N. Broad Street  
Philadelphia, PA 1914
- Wyoming  
4700 N. Broad Street  
Philadelphia, PA 19141
- Logan  
5100 N. Broad Street  
Philadelphia, PA 19141

These existing stations are not currently accessible and are serviced by stairs only. Each station has four uncovered stair entrances at each corner of their respective intersections. The proposed ADA Improvements project includes the addition of two new elevators at each station, one servicing each platform. Existing stair entrances are to receive a new, gated headhouse enclosure, where possible. All stair treads and handrails will be replaced. Hunting Park and Logan Station also have existing railings listed on the Philadelphia Register of Historic Places. A concurrent package is being submitted to the Philadelphia Historic Commission for their review. These railings are intended to remain and design approaches for each location are described below. This project will also implement SEPTA's system-wide signage and wayfinding standards.

The stations are located in series and are generally intended to read cohesively along this northern stretch of the SEPTA's Broad Street Line. The architecture uses similar design elements, intended to be used as a kit of parts, and responds to key design goals including ease of maintenance, durability, longevity, security, and repeatable easy-to-replace elements. The proposed stair headhouse design closely follows SEPTA's standard design including a sloped standing seam metal roof, structural steel angle posts with aircraft cables for the perimeter, a bar stock gate at street level, and new granite-clad curbs. The elevator headhouse design has a similar appearance using structural steel angle posts. Other elements include glass block on the lower portion of the elevator, granite-clad curb, canopy over the

*We Make a Difference*

# Michael Baker

## INTERNATIONAL

door, and bollards for pedestrian safety where needed. An additional elevator headhouse feature is the illuminated angled metal ceiling at the top of the elevator to create a glassy beacon for ease of identification and wayfinding. Both headhouses feature stainless steel finishes.

### **Hunting Park**

The proposed elevator for the northbound platform is situated at the northeast station entrance at the Bristol Street triangle near the historical stair entrance, creating a visible station entrance and providing ease of access to the adjacent bus stop. This location also creates no impact to local businesses. This location also has created the opportunity to improve bus stop waiting and elevator queuing area by enhancing a small amount of existing hardscaping. The second elevator is located at the southwest station entrance along N. Broad Street. This location also does not impact businesses or driving sightlines. The wide width of the sidewalk along N. Broad Street also provides required clearances without impacting curb lines.

This station has one historic railing remaining at the existing northeast entrance and a portion of a historic railing at the northwest station entrance. Both historic elements are intended to be cleaned, repainted, and reinstalled in place on a new granite-clad curb. The stainless steel stair headhouse design respects and complements the existing historic railing, following the rhythm of its existing balustrades using structural steel angles, a shape used to provide a delicate appearance. At the northwest stair where the historical railing fragment is located, a new railing is proposed to emulate the scale and repetition of elements, while providing a distinct modern appearance. This entrance does not receive a covered headhouse nor street-level gates due to the adjacency of the existing building and business entrance.

### **Wyoming**

The proposed elevator for the northbound platform is positioned on the southeast corner of N. Broad and created a central entrance for the station stair entrance and elevator queuing. This location does not impact the existing church property and provides ease of access to the bus stop. The proposed curb bump out, aligned to match the extent of the curb across N. Broad Street, provides a layer of pedestrian safety and allows users to circulate on either side of the elevator. The southbound elevator is located on the southwest corner, also creating a central station entrance without impacting existing properties.

All four existing stair entrances are proposed to have the new headhouse enclosure with street-level gates.

### **Logan**

The proposed southbound elevator is located near the southwest corner of the station within the adjacent property area. With the elevator out of the right-of-way, this elevator position does not impact sidewalk circulation. The northbound elevator is situated near the existing northeastern station entrance to avoid conflict with the existing gas station property drive lanes.

This station has two historic railings, located at the northeast and northwest corners of the station, which will be cleaned, repainted, and installed in place on a new granite-clad curb. Due to the unique condition of the overpass, these station entrances will not receive new stair headhouse enclosures. Each

**Michael Baker**

**I N T E R N A T I O N A L**

of these entrances currently has an overhead sign box supported by two painted metal supports marking the stair entrance to the station. The proposed design replaces the existing sign box with a new powder coated metal sign box and direct printed aluminum sign panel, indicating the station. The existing support posts will remain. The southeast and southwest station entrances are proposed to have the new headhouse enclosure with street-level gates.

Supplemental documents for Logan station will be submitted by April 3, 2024 for the April 10, 2024 meeting. Materials for Hunting Park and Wyoming stations were submitted for the March 13, 2024 meeting and continued to the April 10, 2024 meeting.

Please feel free to contact me with any questions at 215-385-6348 or by email at [cfrances@septa.org](mailto:cfrances@septa.org) or [Chantal.frances@mbakerintl.com](mailto:Chantal.frances@mbakerintl.com).

We look forward to presenting this project.

Warmly,



Chantal Frances, AIA  
Project Manager, Michael Baker International

CC: Sean McMahon, SEPTA  
Glen Hair, Gannet Fleming



PHILADELPHIA ART COMMISSION SUBMISSION - 04/10/24

**LOGAN STATION  
ADA IMPROVEMENTS**

5100 N. BROAD ST  
PHILADELPHIA, PA 19141

PREPARED BY:



1801 MARKET STREET, SUITE 2600  
PHILADELPHIA, PA 19103



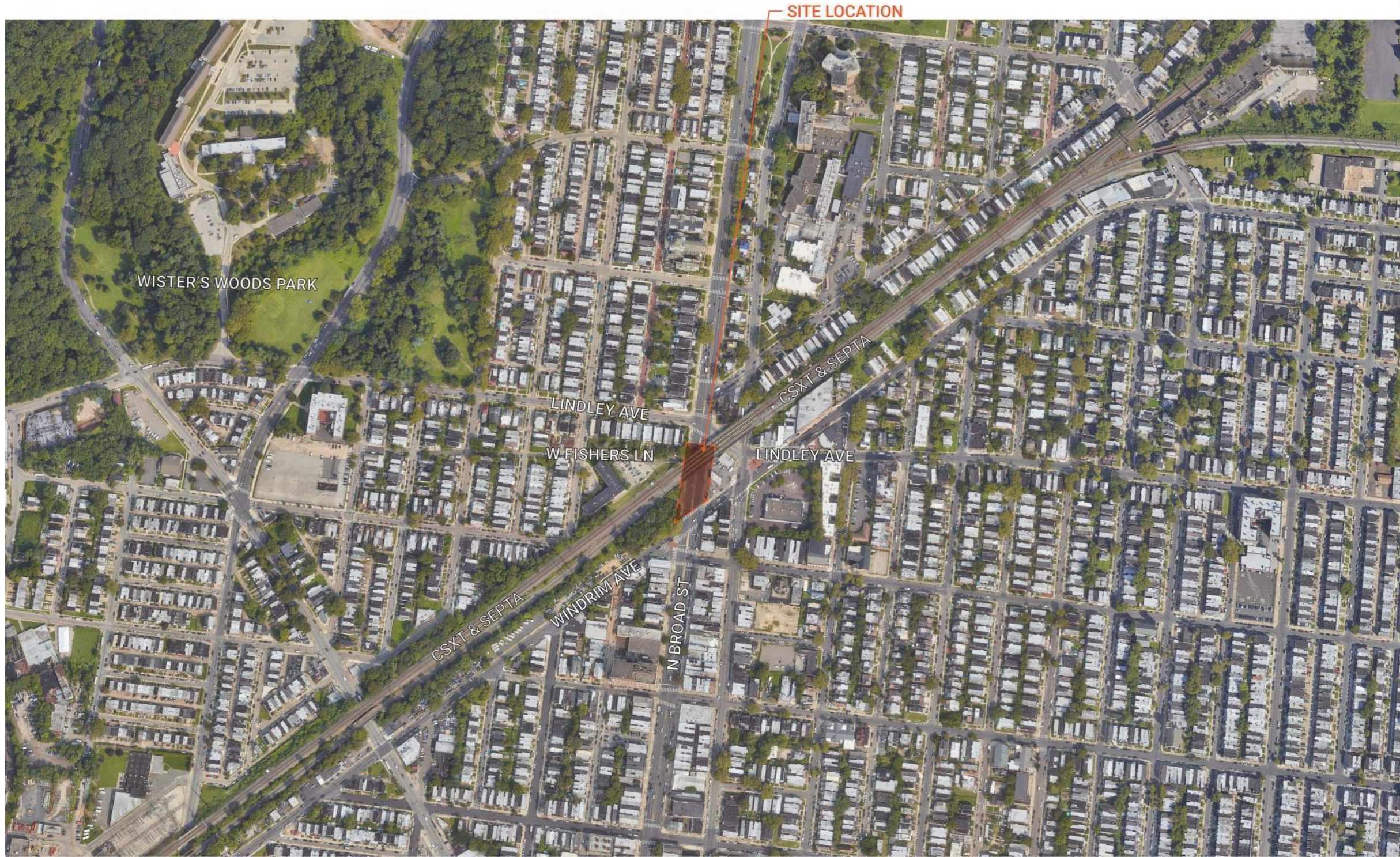

Michael Baker  
INTERNATIONAL



## NORTH BROAD STATION ADA IMPROVEMENTS

LOGAN  
SITE LOCATION  
04/10/24

**A-01**



SOUTHEAST ENTRANCE (NORTHBOUND)

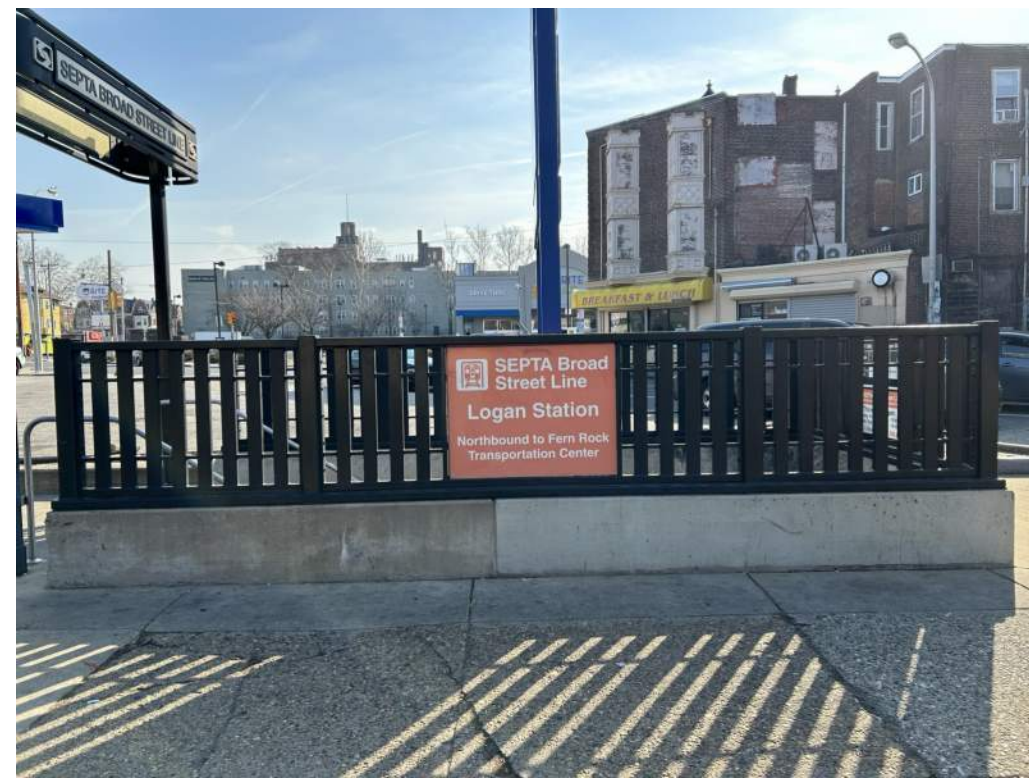

SOUTHEAST ENTRANCE (NORTHBOUND)

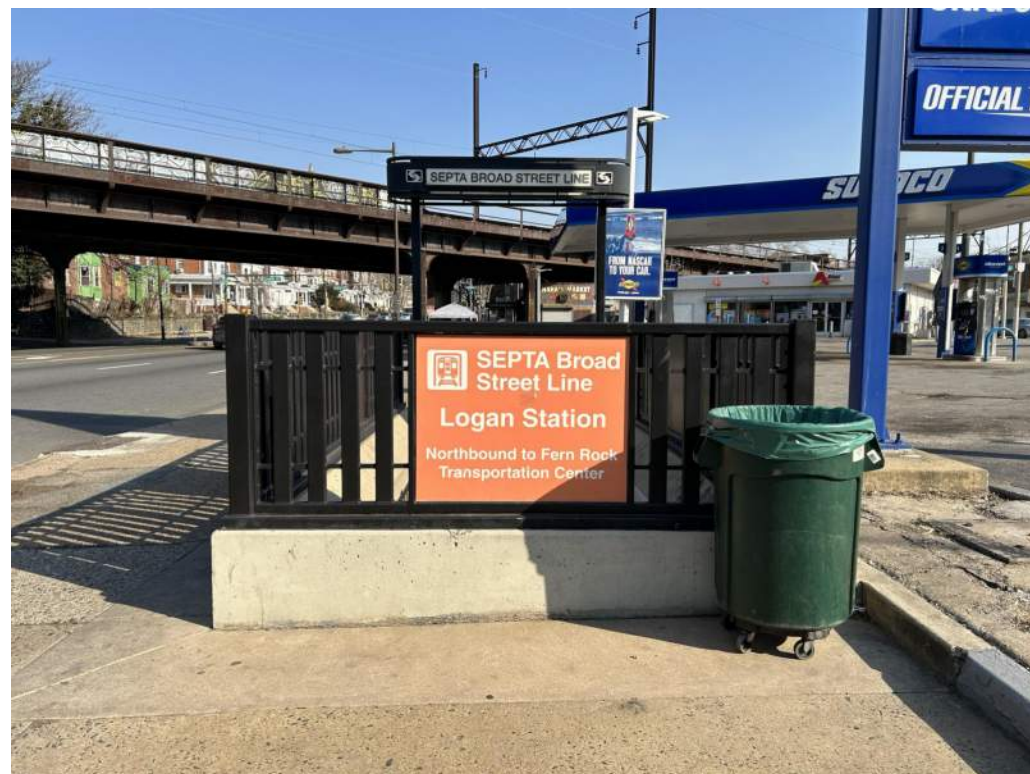

SOUTHEAST ENTRANCE (NORTHBOUND)

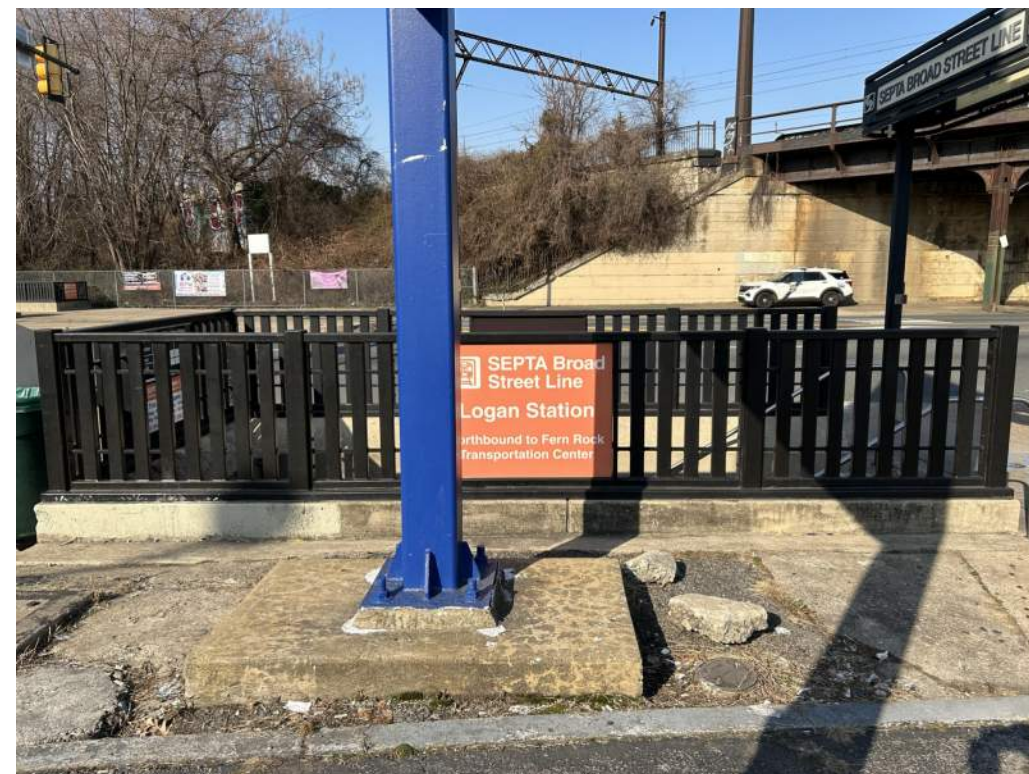

SOUTHEAST ENTRANCE (NORTHBOUND)



## NORTH BROAD STATION ADA IMPROVEMENTS

LOGAN

EXISTING CONDITIONS PHOTOGRAPHS

04/10/24

**A-02**



SOUTHWEST ENTRANCE (SOUTHBOUND)

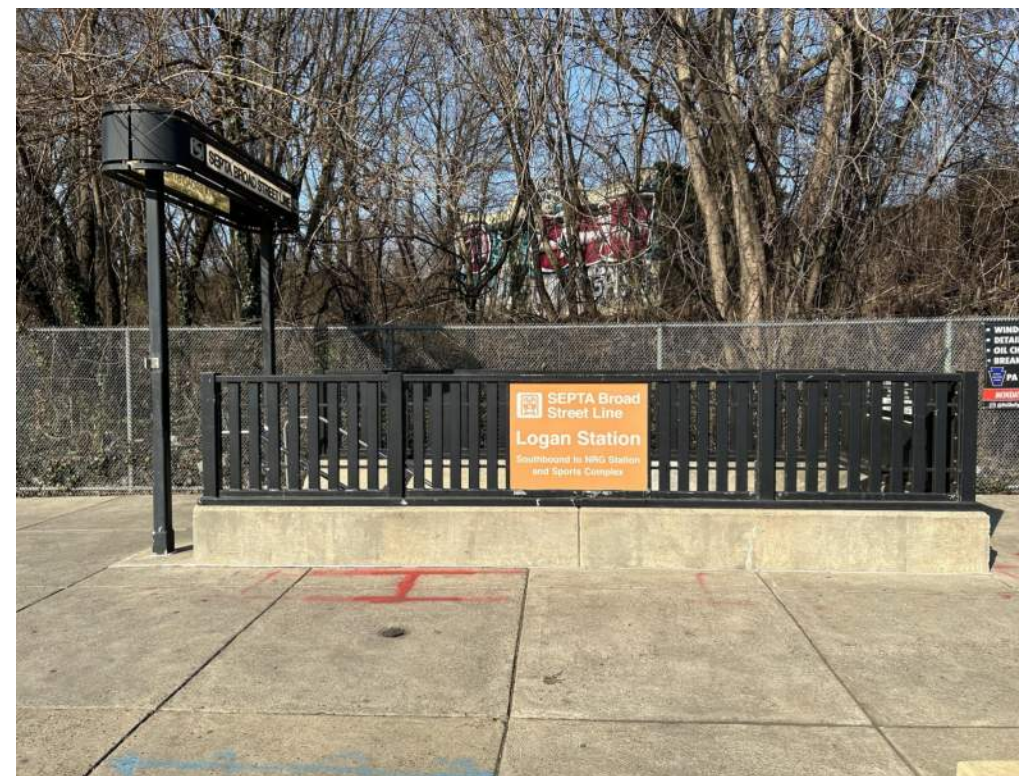

SOUTHWEST ENTRANCE (SOUTHBOUND)

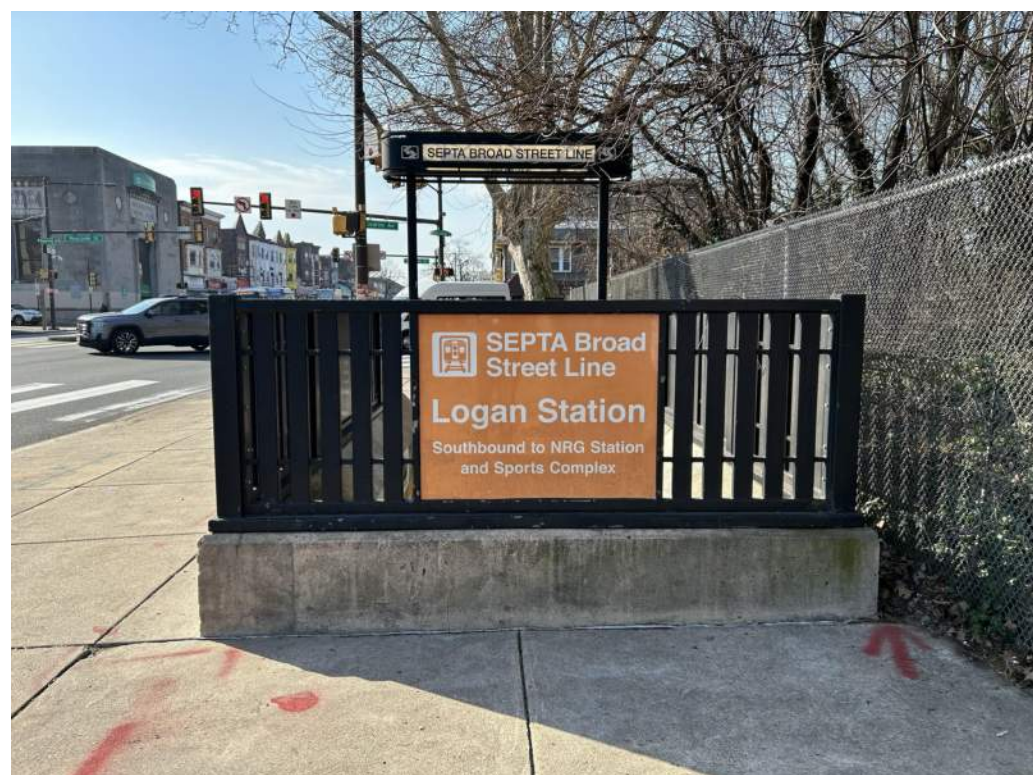

SOUTHWEST ENTRANCE (SOUTHBOUND)



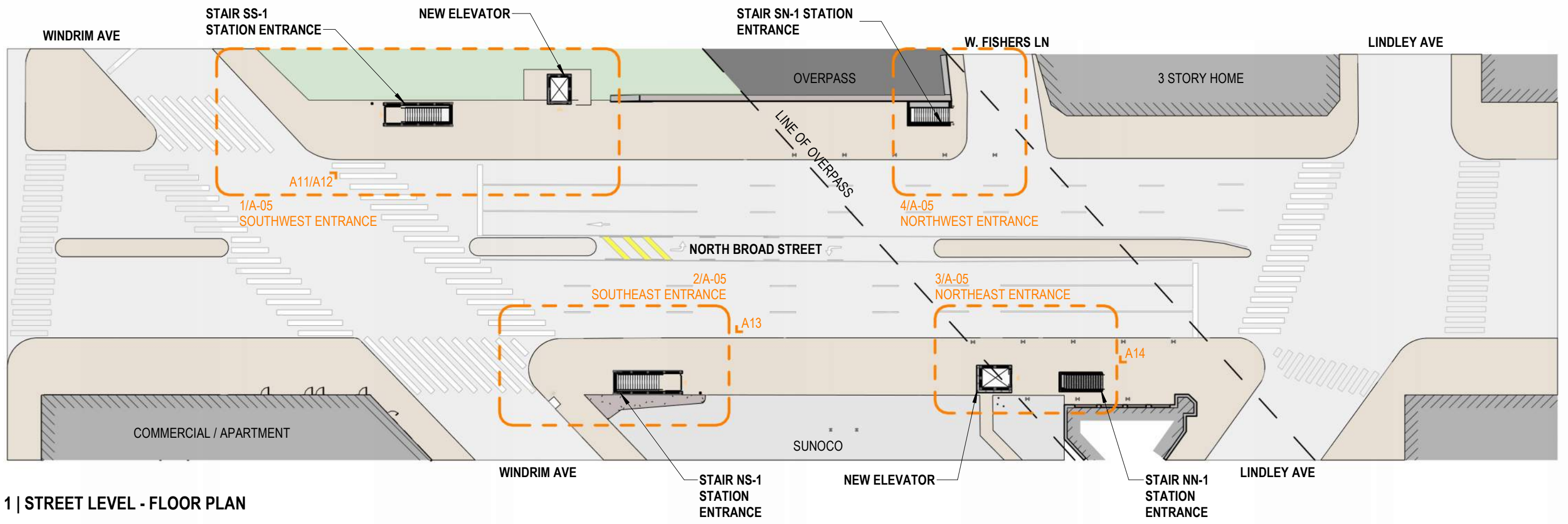

1 | STREET LEVEL - FLOOR PLAN

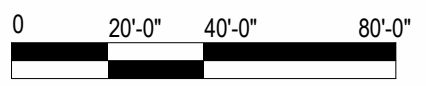

SCALE: 1" = 40'-0"

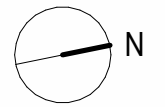

**NORTH BROAD STATION ADA IMPROVEMENTS**  
 LOGAN  
 OVERALL PLAN  
 04/10/24

**A-04**



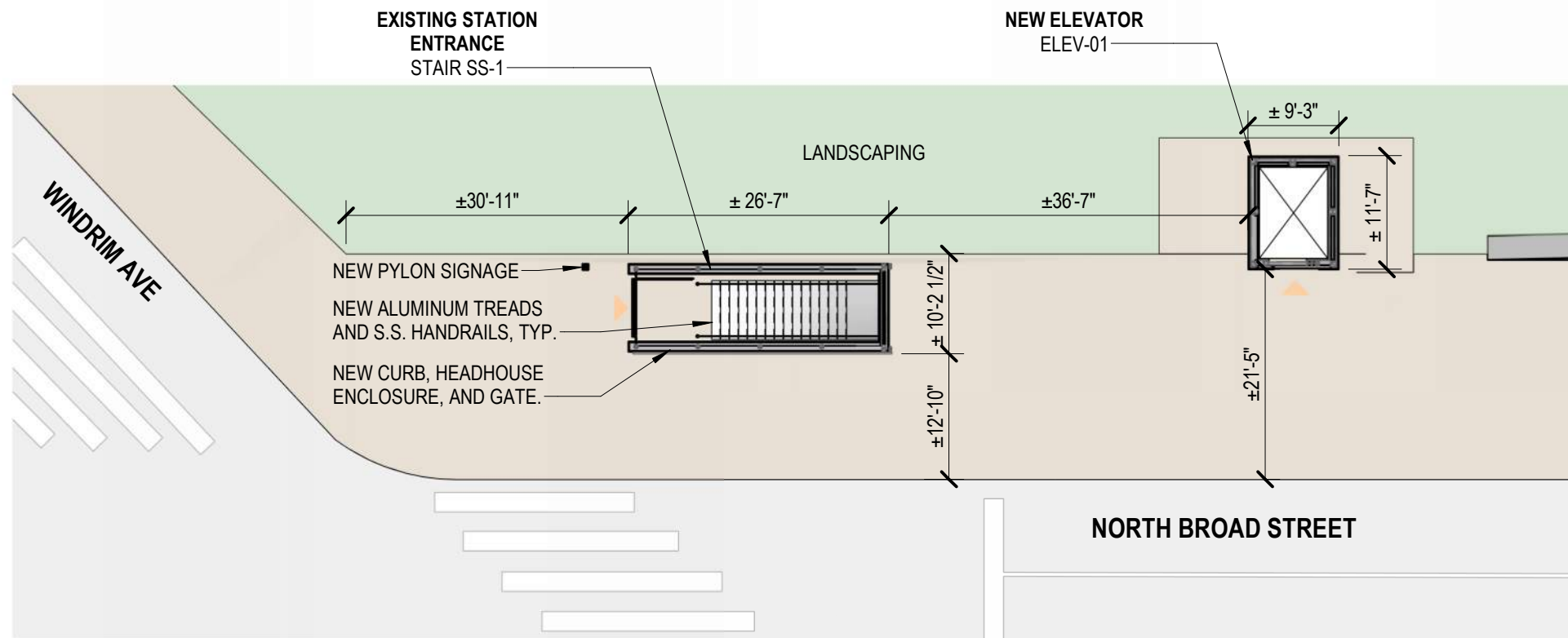

1 | SOUTHWEST STATION ENTRANCE

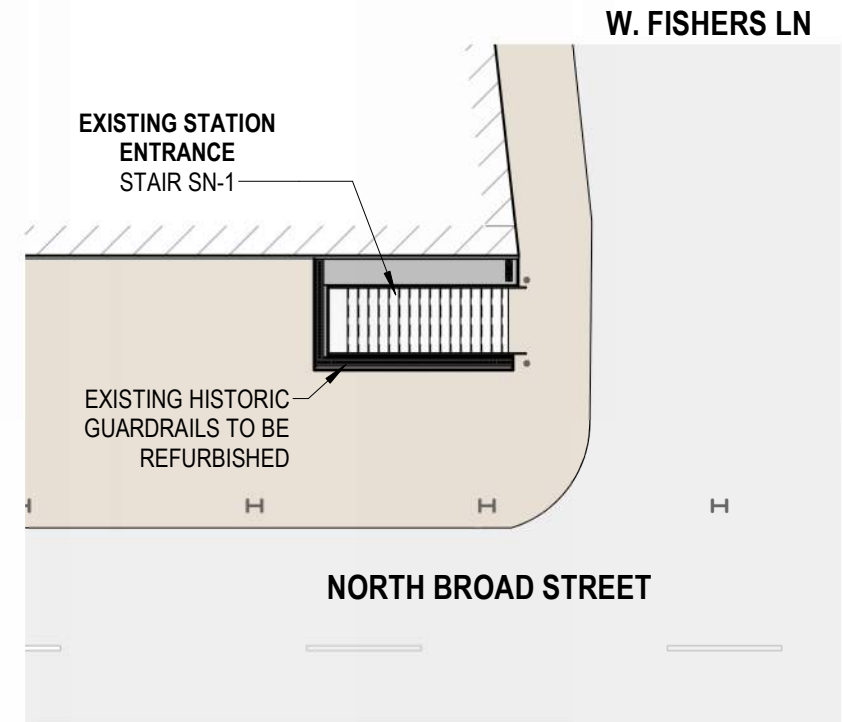

4 | NORTHWEST STATION ENTRANCE

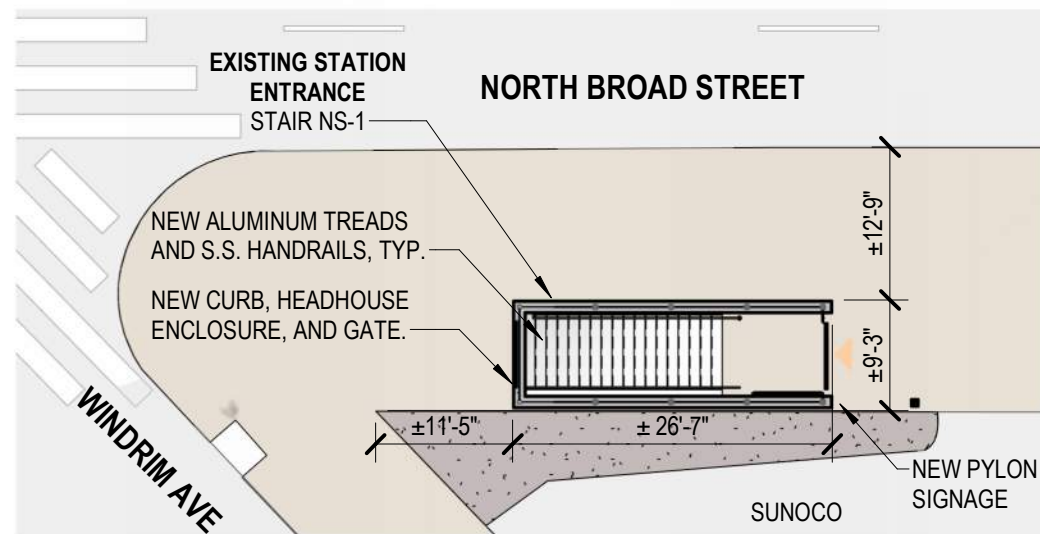

2 | SOUTHEAST STATION ENTRANCE

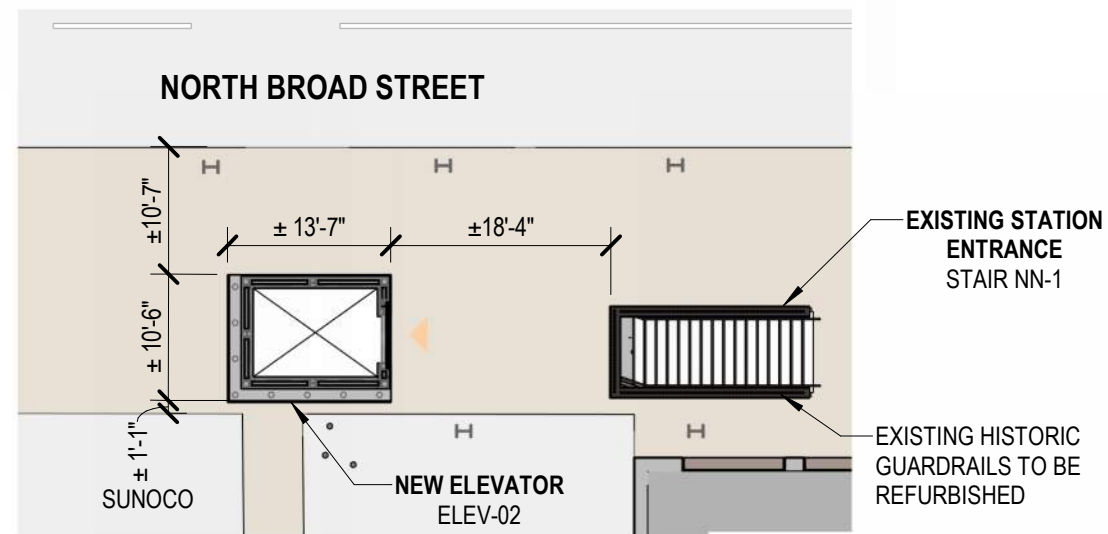

3 | NORTHEAST STATION ENTRANCE

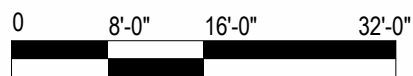

SCALE: 1/16" = 1'-0"



**NORTH BROAD STATION ADA IMPROVEMENTS**

LOGAN  
PLANS  
04/10/24

**A-05**

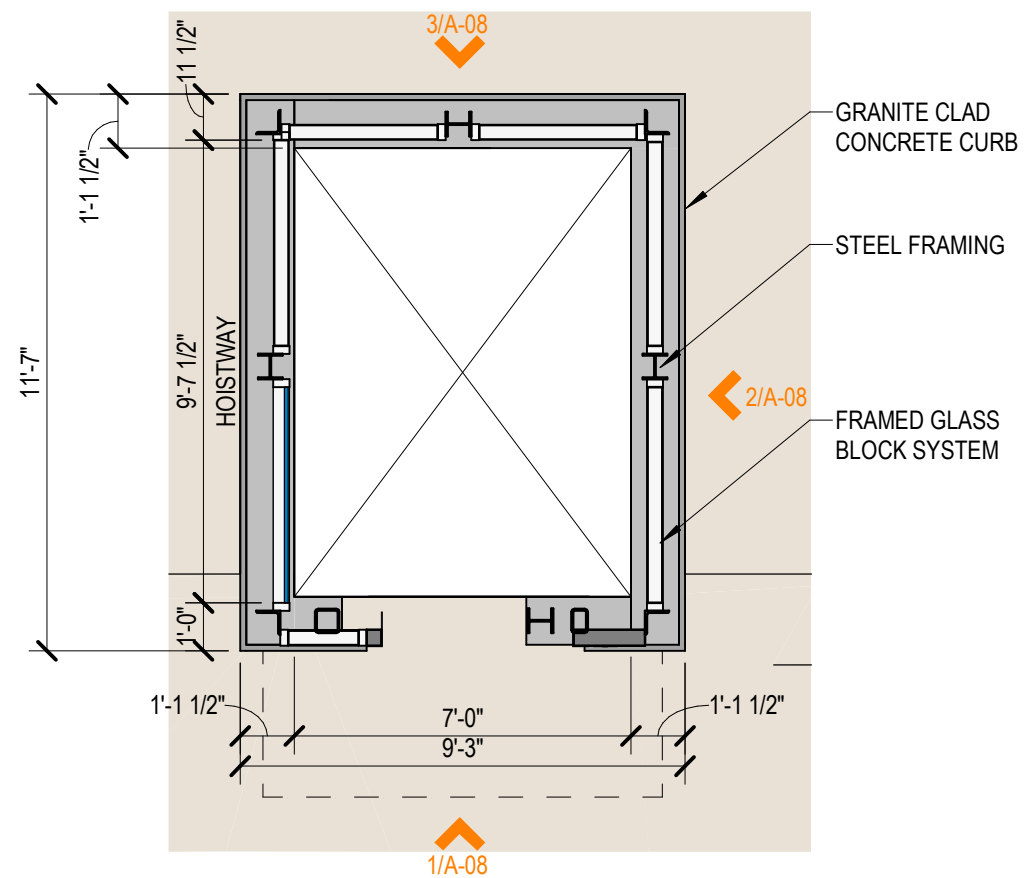

1 | ELEV-1 - SOUTHBOUND - PLAN

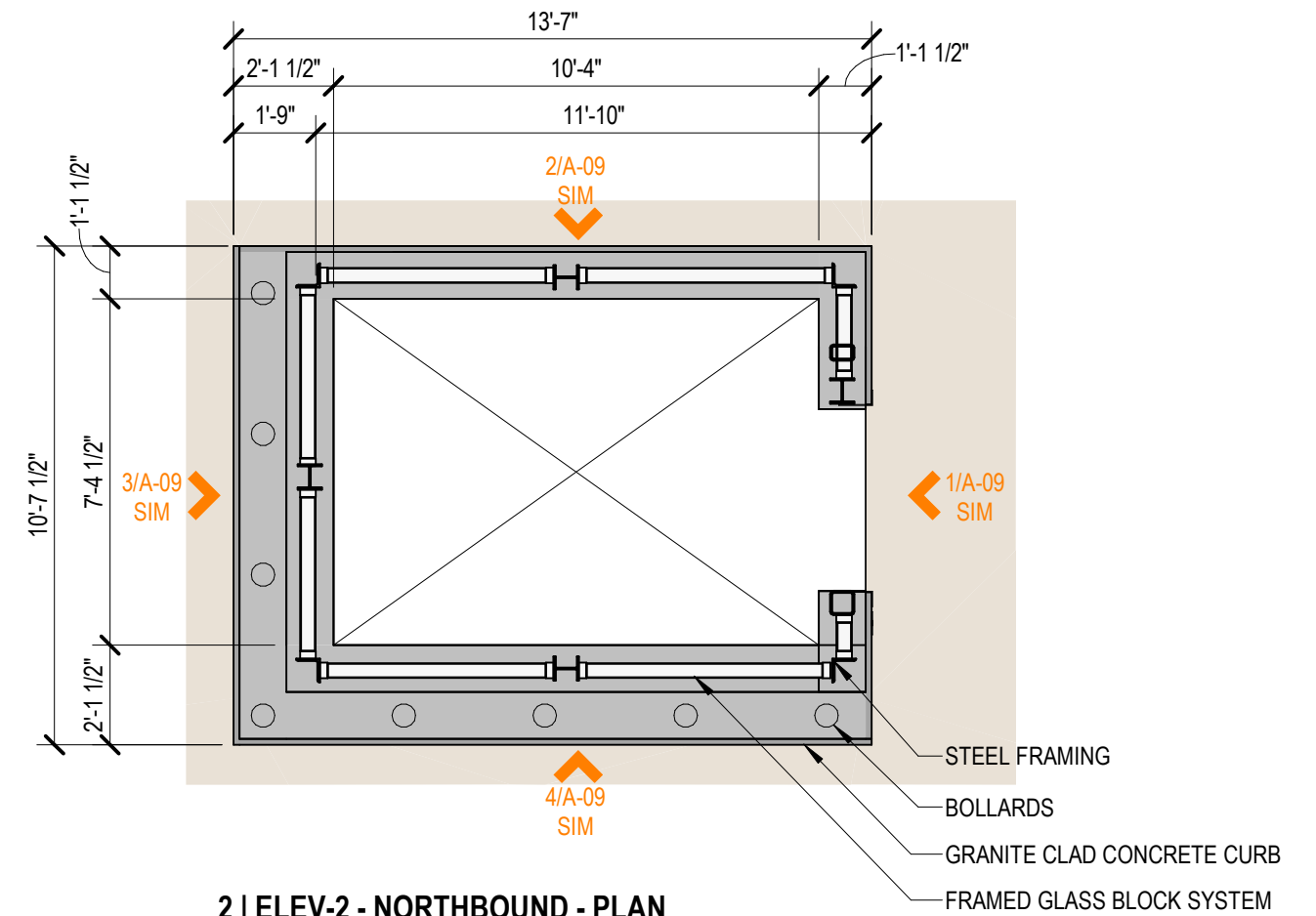

2 | ELEV-2 - NORTHBOUND - PLAN

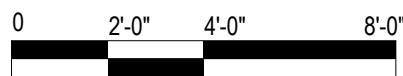

SCALE: 1/4" = 1'-0"



**NORTH BROAD STATION ADA IMPROVEMENTS**

LOGAN

ENLARGED PLANS - ELEVATOR

04/10/24

**A-06**

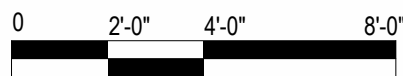
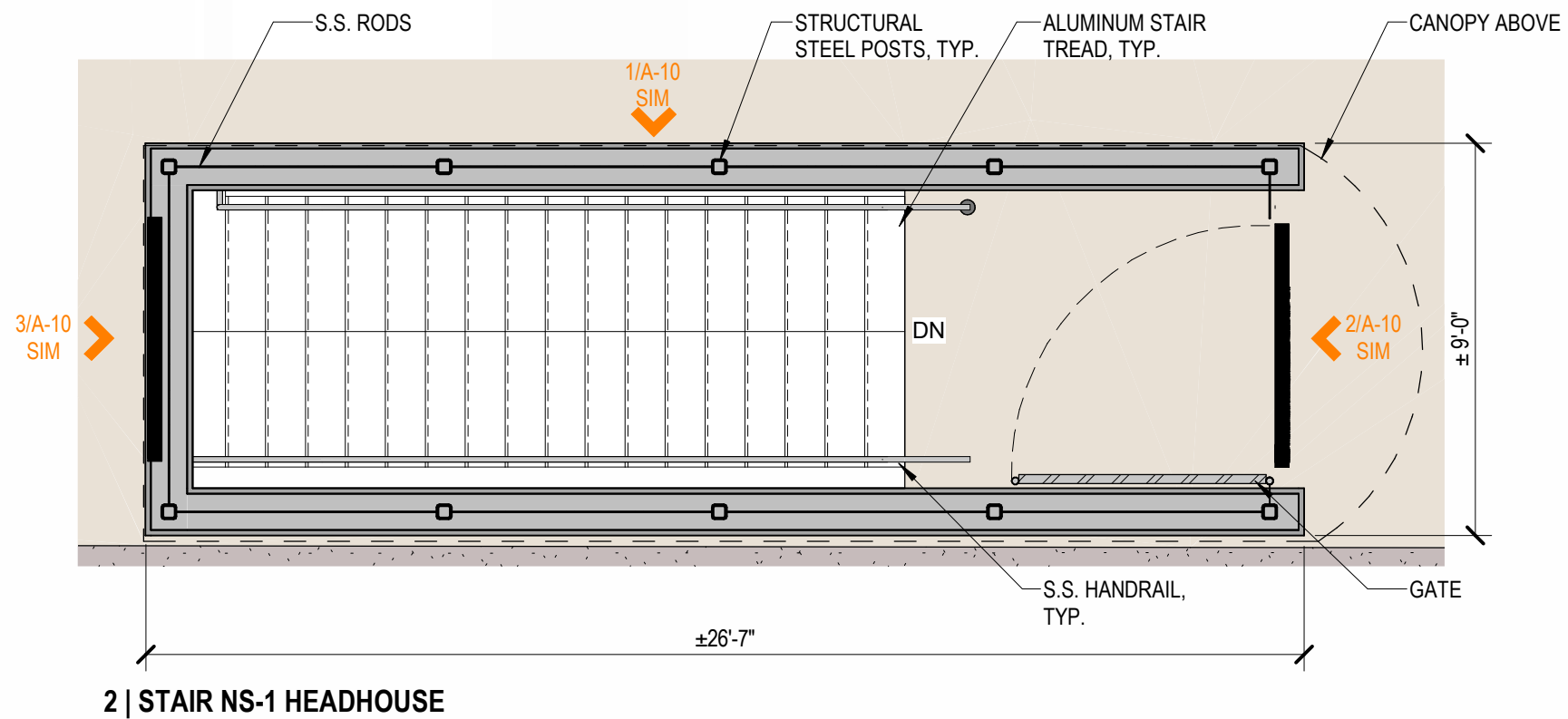
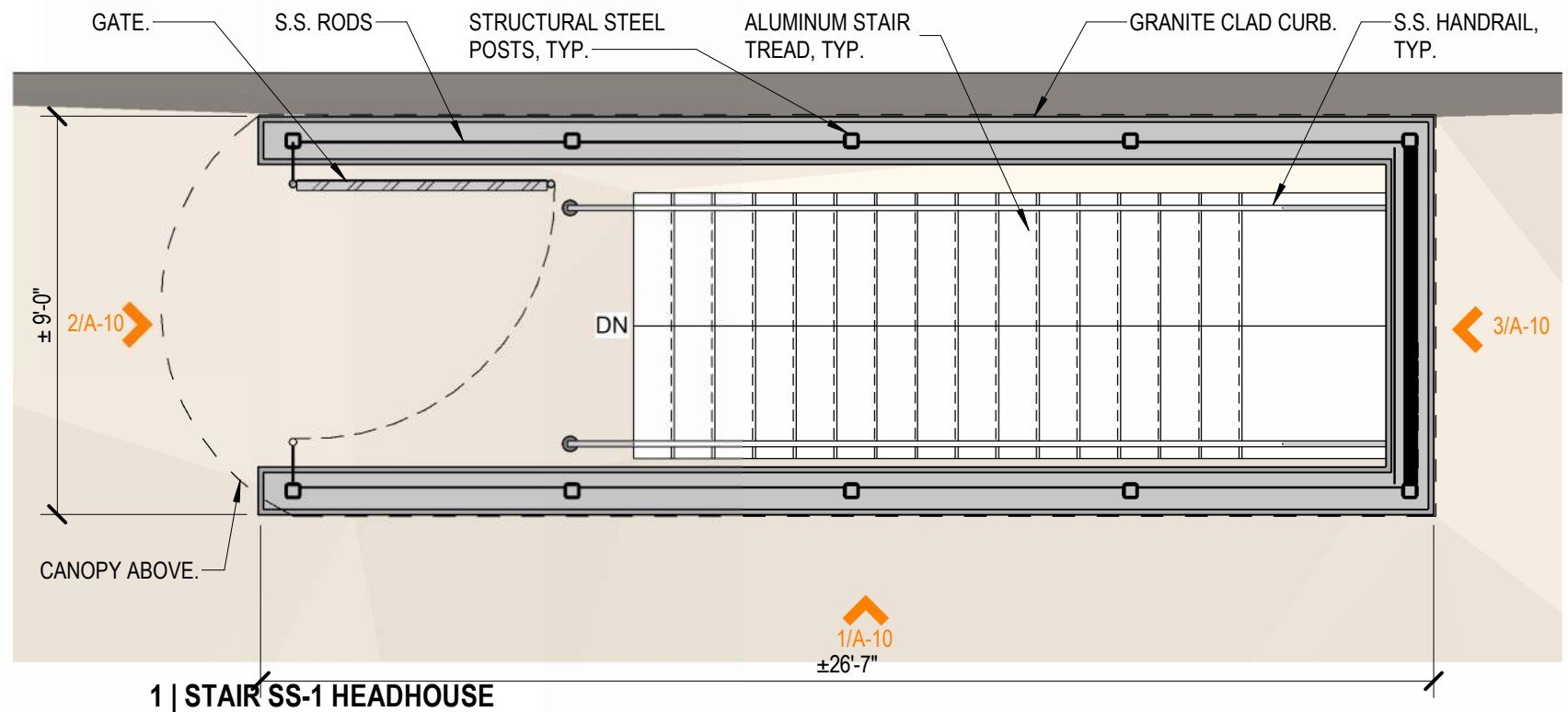

SCALE: 1/4" = 1'-0"

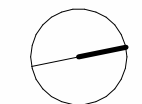

**NORTH BROAD STATION ADA IMPROVEMENTS**

LOGAN

ENLARGED PLANS - STAIR

04/10/24

**A-07**

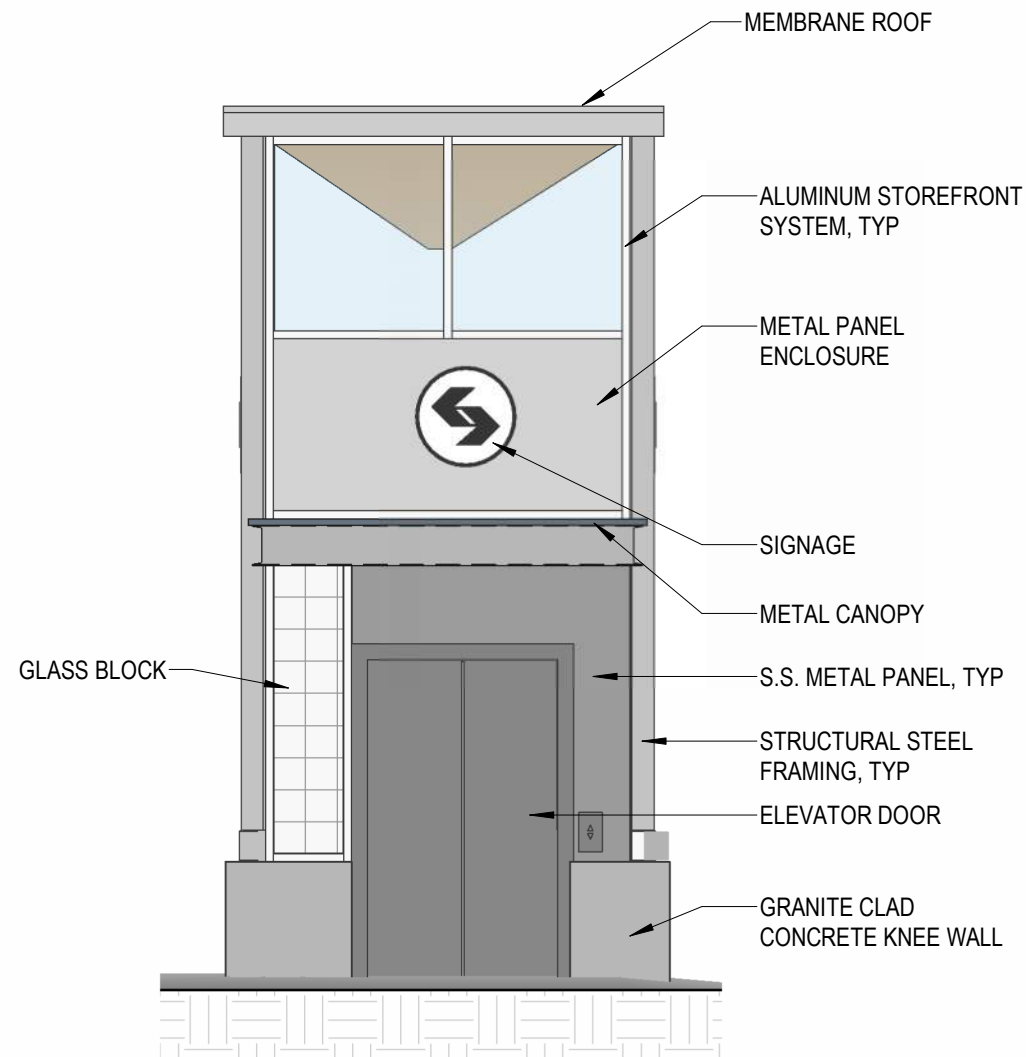

1 | ELEV-1 - FRONT ELEVATION

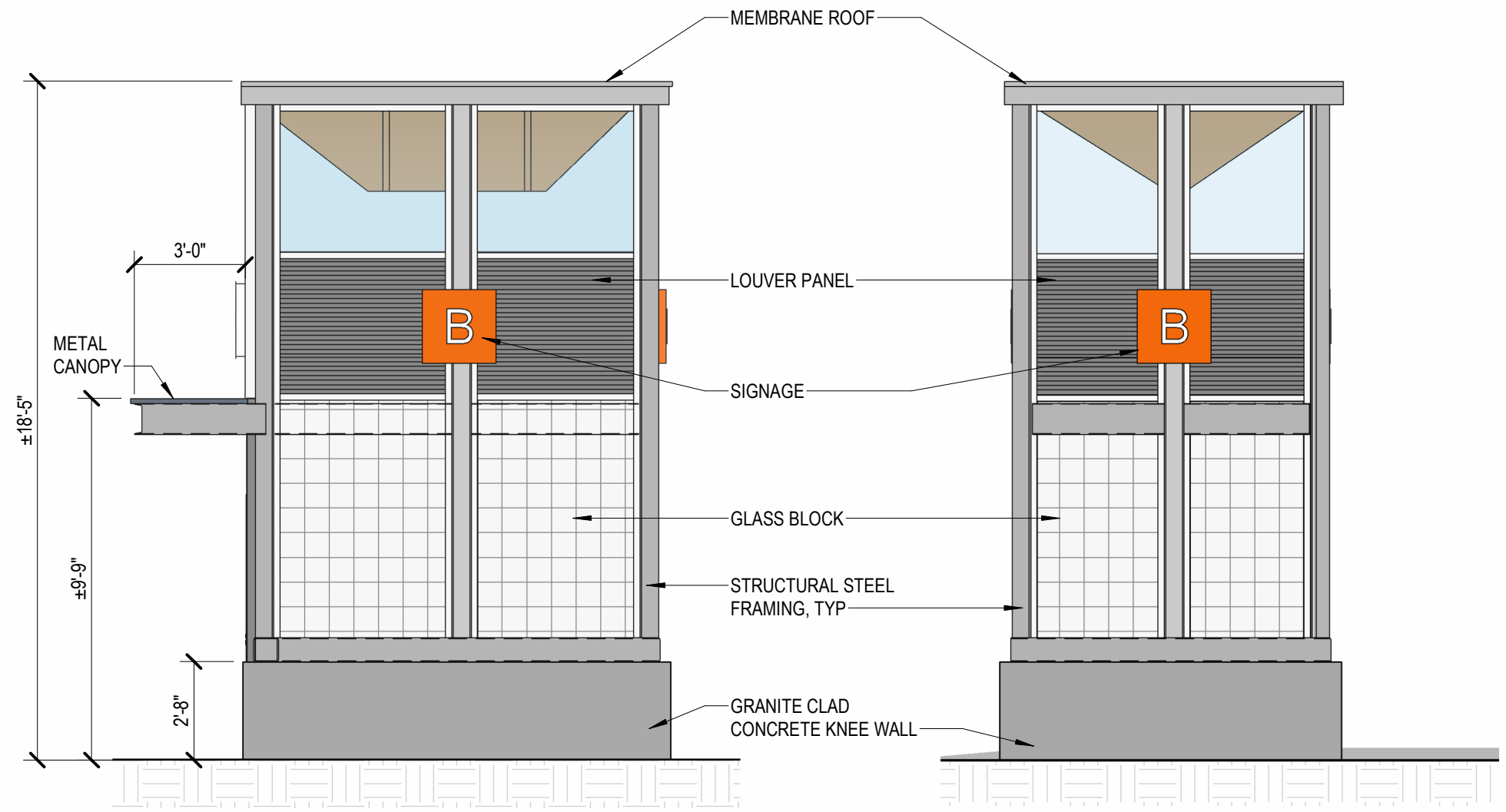

2 | ELEV-1 - SIDE ELEVATION

3 | ELEV-1 - REAR ELEVATION

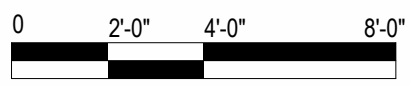

SCALE: 1/4" = 1'-0"



**NORTH BROAD STATION ADA IMPROVEMENTS**

LOGAN  
ELEVATIONS  
04/10/24

**A-08**

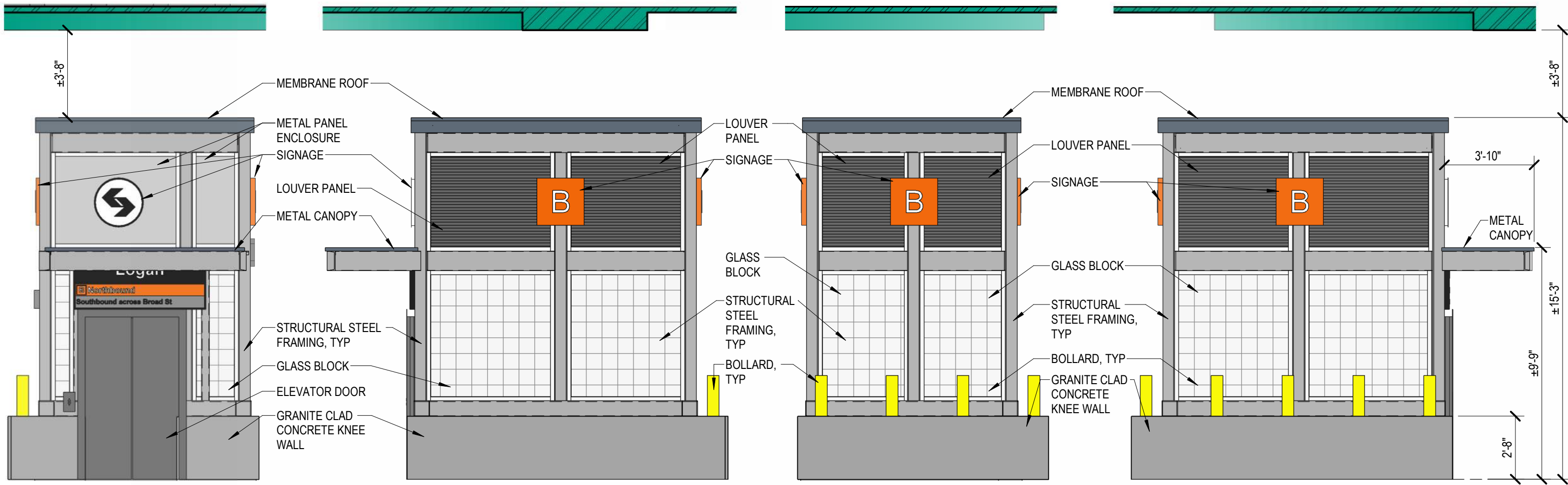

1 | ELEV-1 - FRONT ELEVATION

2 | ELEV-1 - SIDE ELEVATION

3 | ELEV-1 - REAR ELEVATION

4 | ELEV-1 - SIDE ELEVATION

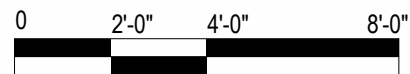

SCALE: 1/4" = 1'-0"



**NORTH BROAD STATION ADA IMPROVEMENTS**

LOGAN  
ELEVATIONS  
04/10/24

**A-09**

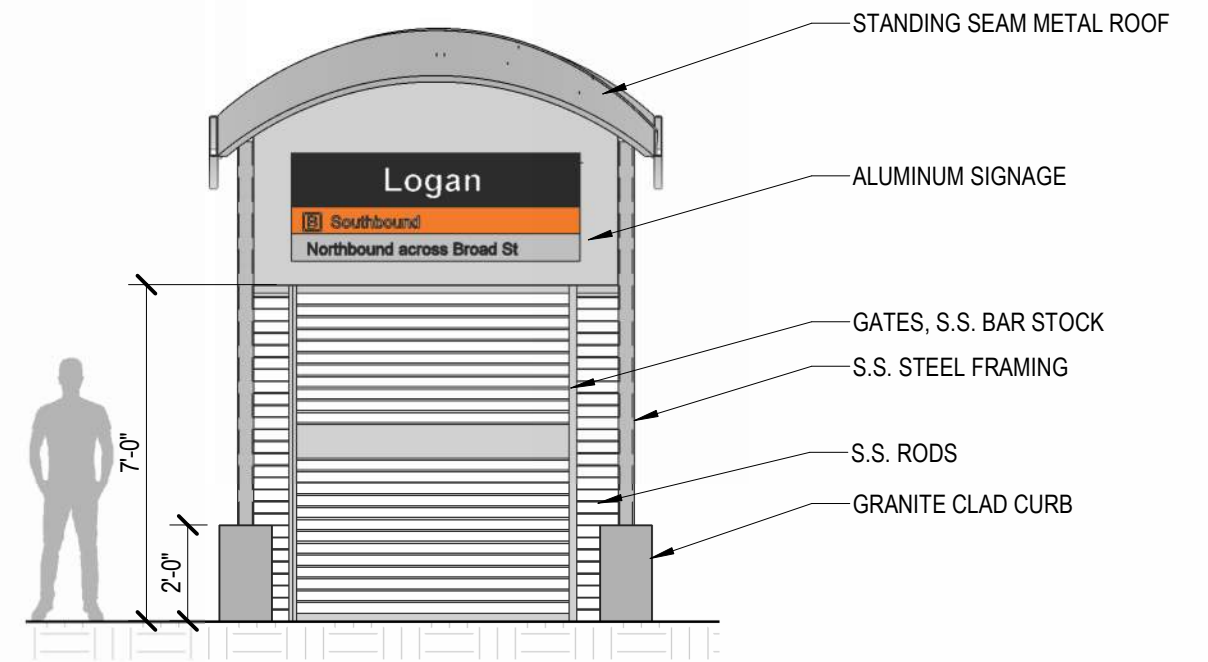

2 | STAIR SS-1 - FRONT ELEVATION

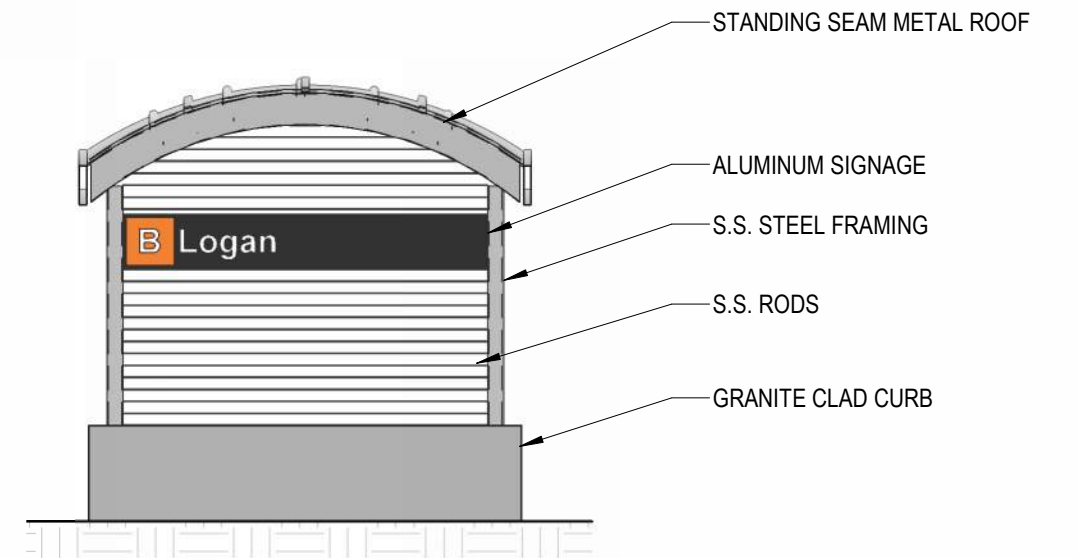

3 | STAIR SS-1 - REAR ELEVATION

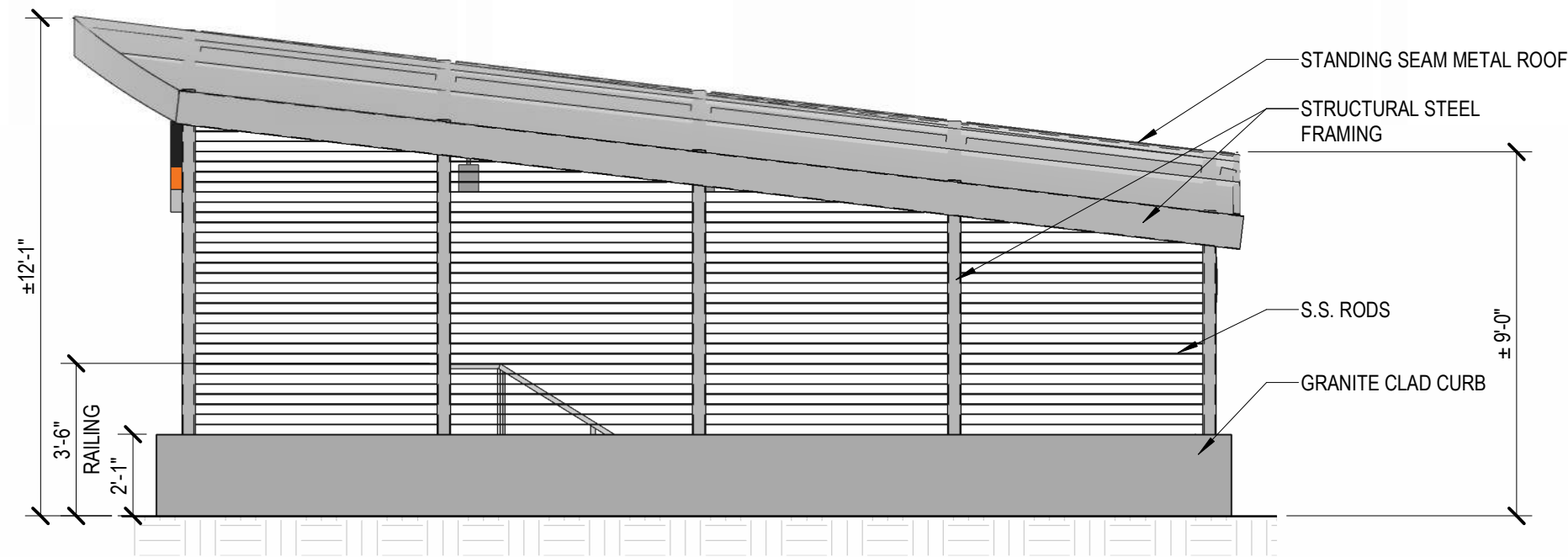

1 | STAIR SS-1 - SIDE ELEVATION

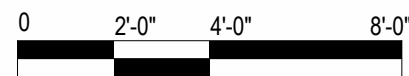

SCALE: 1/4" = 1'-0"



NORTH BROAD STATION ADA IMPROVEMENTS

LOGAN  
ELEVATIONS  
04/10/24

**A-10**



Michael Baker  
INTERNATIONAL



## NORTH BROAD STATION ADA IMPROVEMENTS

LOGAN

RENDERING - DAYTIME

04/10/24

**A-11**



Michael Baker  
INTERNATIONAL



## NORTH BROAD STATION ADA IMPROVEMENTS

LOGAN

RENDERING - EVENING

04/10/24

**A-12**





**NORTH BROAD STATION ADA IMPROVEMENTS**

**LOGAN**

RENDERING - NS STAIR HEADHOUSE

04/10/24

**A-13**



Michael Baker  
INTERNATIONAL



## NORTH BROAD STATION ADA IMPROVEMENTS

LOGAN

RENDERING - NORTHBOUND ELEVATOR

04/10/24

**A-14**